





GENUINE CAR-NAVIGATION UNIT

INSTALLATION INSTRUCTIONS

Thank you for purchasing a genuine Mazda accessory.
Before removal and installation, be sure to thoroughly read these instructions.
Please read the contents of this booklet in order to properly install and use the car-navigation unit. Your safety depends on it.
Keep these instructions with your vehicle records for future reference.

WARNING

- There are several  **WARNING** and  **CAUTION** sections in this booklet concerning safety when installing or removing the car-navigation unit. Always read and follow them in order to prevent injuries, accidents, and possible damage to the vehicle.
 -  **WARNING:** Indicates a situation in which serious injury or death could result if the warning is ignored.
 -  **CAUTION:** Indicates a situation in which bodily injury or damage to the vehicle could result if the caution is ignored.
- For areas indicating the tightening torque in this instruction manual, tighten to the specified torque using a torque wrench. For areas in which the tightening torque is indicated inside parentheses (), the tightening torque is indicated as a reference value, however tightening using a torque wrench is not necessary.
- Do not modify the car-navigation unit.
- Do not install the car-navigation unit in any way other than described in the following instructions.
- If in any doubt, please ask your Mazda dealer to install the accessory in order to prevent errors in installation.
- If you have any questions about the use of the accessory, ask your Mazda dealer for proper advice before using it.
- Mazda and its suppliers are not responsible for injuries, accidents, and damage to persons and property that arise from the failure of the dealer or installer to follow these instructions.
- To ensure safety and reliability of the work, installation, removal and disposal work must be carried out by an Authorized Mazda Dealership.
- Be careful not to lose removed parts, and be sure that they are kept free from scratches, grease or other dirt.

PART NAME: CAR-NAVIGATION UNIT
PART NUMBER: KF69 79 EZX (MEXICO)
KD37 79 EZX (US/CANADA)
VEHICLE: MAZDA CX-5

NOTE

To the dealer

- Please turn over these instructions to the customer after installation.

To the customer

- Keep these instructions after installation. The instructions may be necessary for installing other optional parts or removal of this accessory.
- Should the vehicle or this accessory be resold, always leave these instructions with it for the next owner.

GB

F

E

1. PARTS



NOTE: Requires factory installed 5.8" display. Not needed on vehicles with the Technology Package (they already have factory navigation). All parts are the same as OE (including SD card KD37-66-EZ1).

▼ PARTS LIST

NOTE:

- Before installation, verify that the kit includes all the following parts and that they are free of dirt, scratches, or damage.

- KF69 79 EZX (MEXICO), KD37 79 EZX (US/CANADA)

Part	Part name	Qty.	Part	Part name	Qty.	Part	Part name	Qty.
	Car-navigation unit	1		Installation instruction	1		Owner's manual	1

2. BEFORE INSTALLATION

▼ REQUIRED TOOLS

☆Socket wrench (10mm) or Spanner wrench (10mm) ☆Torque wrench ☆Clean rag (soft cloth)

⚠ WARNING

- To prevent short related accidents while performing procedures, disconnect the negative battery cable before beginning any work.
- When disconnecting the connector, hold the connector itself to remove while pressing the connector lock.
- Do not apply excessive force to the wiring harness as it could cause an open circuit.
- When locking connectors, listen for a click that will indicate they are securely locked.
- Be careful not to pinch the wiring harness. Otherwise, the harness may be broken.

⚠ CAUTION

- When removing and installing vehicle parts, make sure they are clean with no scratches. Also, be sure to cover the vehicle body with protectors or mats when removing/installing parts to prevent scratches and dirt.

NOTE:

- Refer to the applicable Workshop Manual for removal and installation of vehicle parts. Not following the procedures for removal/installation in the Workshop Manual could result in an accident or vehicle malfunction.
- When the negative battery cable is removed, the clock, radio, trip meters and other memories will be erased. Before performing work, record the content of the memory.

3. VEHICLE PARTS REMOVAL

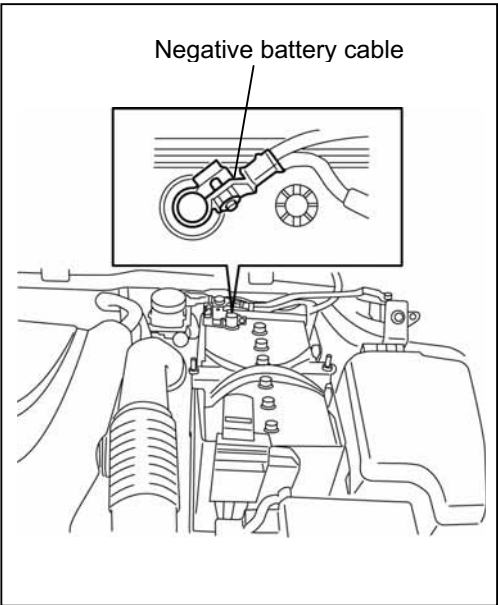

Negative battery cable disconnection

1. Set the selector lever to P range.
(AT vehicles only)

⚠ WARNING

- When removing/installing the parts, park the vehicle on level ground and apply the side brake securely. Be sure to turn the ignition switch off, otherwise the vehicle can move, causing personal injury or vehicle damage.

2. Disconnect the negative battery cable and wrap tape around it to insulate.

⚠ WARNING

- When the negative battery cable is connected during operation, it may cause electric shock or other personal injuries. Disconnect the negative battery cable before removal/installation.

4. INSTALLATION

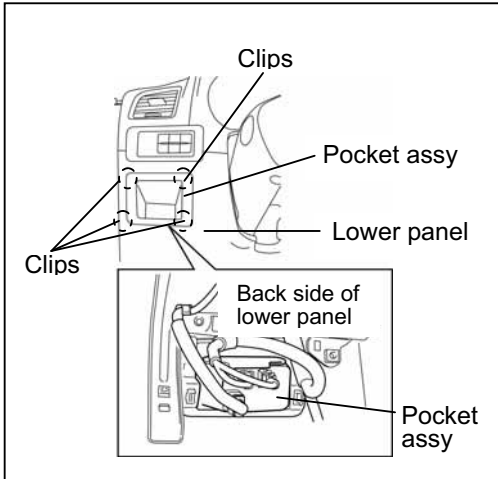

CAR-NAVIGATION UNIT INSTALLATION

Pocket Assy Removal

1. Grasp the pocket assy from the back side of the lower panel and press it out to the vehicle rear.

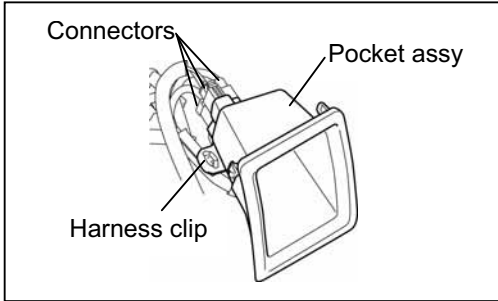

2. Remove the harness clips.
3. Disconnect the connectors.

⚠ CAUTION

- Be careful not to apply excessive force to the wiring harness when removing the connectors.

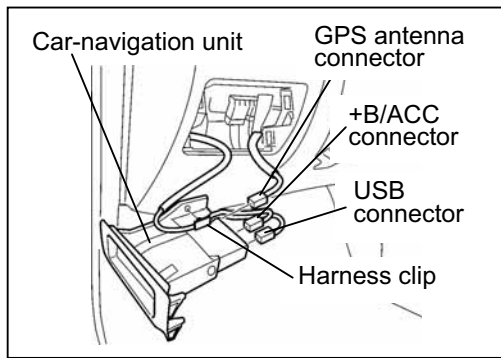

Car-navigation unit Installation

1. Connect the USB, GPS antenna, and +B/ACC connectors to the car-navigation unit.
2. Install the wiring harness clip.

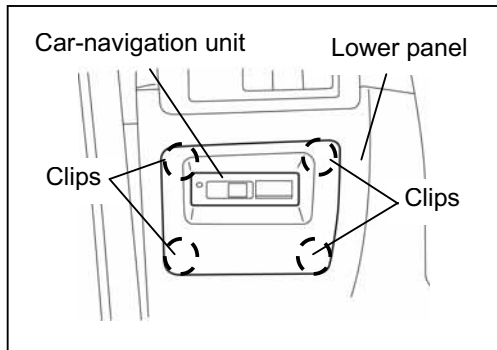

3. Press the clips (4 locations) shown in the figure and install the car-navigation unit to the lower panel.

⚠ CAUTION

- Be careful not to press the car-navigation unit when installing it.

5. OPERATION CHECK

1. Connect the negative battery cable and perform an operation check by referring to the owner's manual applicable to the vehicle.
2. If there is any malfunction, disconnect the negative battery cable and verify that each connector is properly connected and the wiring harnesses are not damaged or pinched, then perform the operation check again. If it does not operate normally, contact the dealer where the unit was purchased.

- After installing the car-navigation unit, verify the connections of the GPS antenna, +B/ACC, and USB connectors using the following procedure:

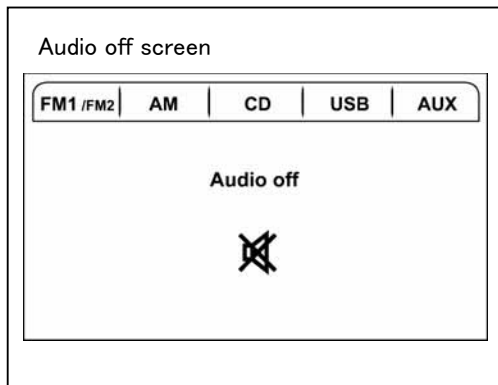

Connection verification of GPS antenna connector

1. Turn the ignition switch to the ON position.
2. After the opening screen ends, the Audio off screen is displayed.

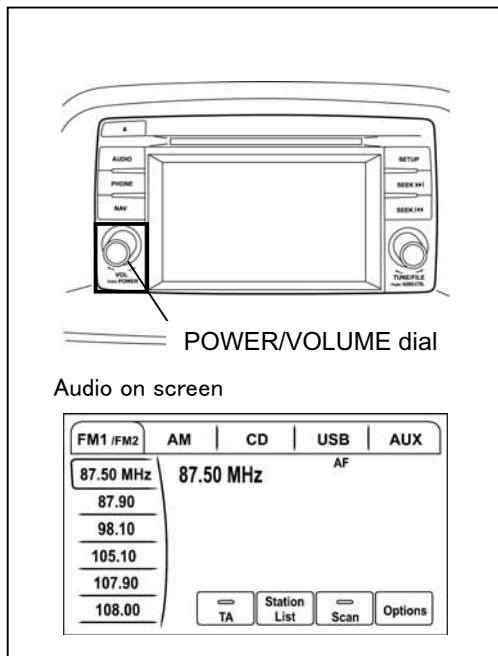

3. Press the POWER/VOLUME dial to switch to the on screen.

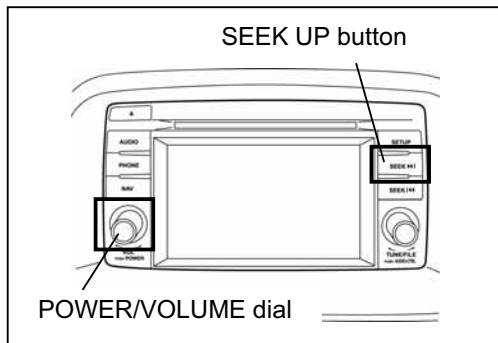

4. Press the POWER/VOLUME dial and SEEK UP button at the same time on the Audio on screen (press POWER/VOLUME dial a little earlier).

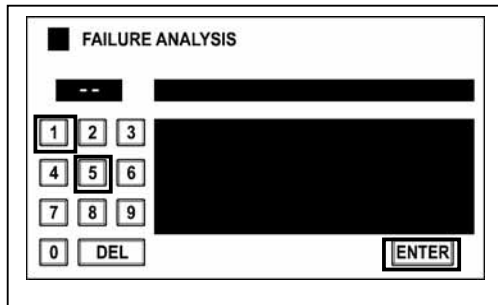

5. After switching to the AUDIO system screen, touch the buttons in the order of “1”, “5” and “ENTER” on the screen.

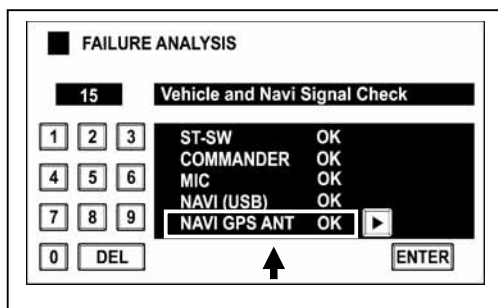

6. After switching to the Vehicle and Navi Signal Check screen, touch “▶” on the screen to switch the display screen to “NAVI GPS ANT”. Verify that “NAVI GPS ANT: OK” is displayed. If not OK, verify the connection condition again.

7. Press the POWER/VOLUME dial to switch to the AUDIO screen.

8. Switch the ignition off

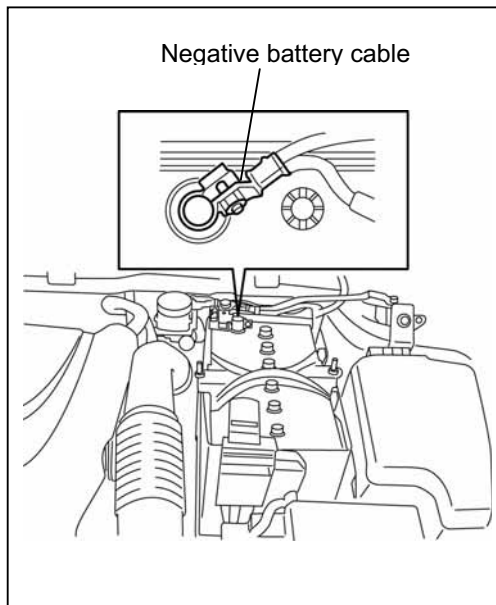
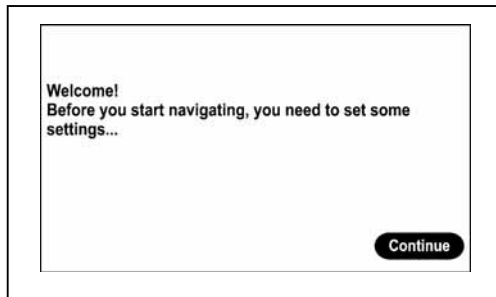
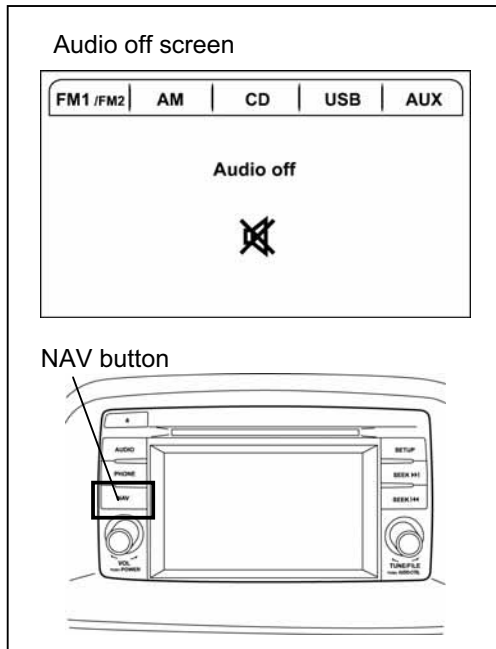

Connection verification of +B/ACC connector and USB connector

1. Turn the ignition switch to the ON position.
2. When the Audio off screen is displayed after the opening screen ends, press the NAV button.

3. When the screen in the figure on the left is displayed, the connection verification is completed. If it is not displayed, verify the connection condition again.

- The procedure from this screen is performed by a user. This procedure ends on this screen.

4. Switch the ignition off.

5. Remove the negative battery cable.

- It is necessary to reset after this procedure. It is reset by removing the negative battery cable.

- After connecting the negative battery cable, restore the vehicle functions using the following procedure.

Connect the negative battery cable.

Tightening torque Nut : 4.0—5.0 N·m

 **CAUTION**

【Power window auto function】

- If the battery is disconnected, the automatic full open/close feature of the power window is disabled. This feature can be recovered by the following procedure.
 1. Turn the ignition switch to the ON position.
 2. Hold down the power window switch until the window is fully open.
 3. Pull up the power window switch to close the window and continue to pull it up for about two seconds after it is fully closed.
 4. If the feature does not function even after the ignition switch is turned off, contact an Authorized Mazda Dealer.

【TPMS system】

- If the battery is disconnected, the TPMS (Tire Pressure Monitoring System) initial setting is reset and the system may not operate normally. This feature can be recovered by the following procedure.
 1. Adjust the tire pressure (verify tire pressure using label on body side with driver's door open).
 2. Turn the ignition switch to the ON position.
 3. Press the TPMS (SET) switch (long-press it until TPMS warning light in meter flashes two times and a beep sounds one time).
 4. Switch the ignition off.
 5. If the TPMS warning light illuminates or flashes even though the above procedure has been performed, contact an Authorized Mazda Dealer.

INSTALLATION INSPECTION SHEET

MAZDA CX-5	CAR-NAVIGATION UNIT
KF69 79 EZX (MEXICO) KD37 79 EZX (US/CANADA)	

A. Vehicle parts reinstallation

- Install removed vehicle parts in the reverse order of "VEHICLE PARTS REMOVAL".

⚠ CAUTION

- Make sure that the vehicle parts are clean before reinstalling. Clean any dirty parts.
- Verify that the connectors are securely connected.

Check

B. Inspection after installation

- Inspect the installed / reinstalled parts for the following items.

Inspection Parts	Check Item (○)			
	Clearance/Fit	Scratches/ Dirt/ Harness interference	Installation/ Tightening/ Engagement	Operation check
Car-navigation unit	○	○	○	○
Negative battery cable		○	○	
Power window auto function				○
TPMS system				○

○ : Applicable

C. Important check items

- Inspect the installed / reinstalled parts for the following items.

Section	Parts Name	Tightening torque	Check
Installation of the negative battery cable	Nut	4.0—5.0 N·m	

Installation inspection sheet for car-navigation unit.

Date _____, _____, _____				
Vehicle. _____				
VIN. _____				
Approved		Checked		Person in charge

The term of validity for this sheet: 3 years.





GENUINE CAR-NAVIGATION UNIT

INSTALLATION INSTRUCTIONS SUPPLEMENT

Thank you for purchasing a genuine Mazda accessory.
Before removal and installation, be sure to thoroughly read these instructions.
Please read the contents of this booklet in order to properly install and use the car-navigation unit.
Your safety depends on it.
Keep these instructions with your vehicle records for future reference.

Due to changes in the vehicle, some additions and changes have been made to the content described in the existing installation instructions (KD37 79EZX/KF69 79 EZX). Please refer to the existing installation instructions (KD37 79EZX/KF69 79 EZX) for all other content that is not related to work procedures which are not covered in this supplement.

WARNING

- There are several  **WARNING** and  **CAUTION** sections in this booklet concerning safety when installing or removing the car-navigation unit. Always read and follow them in order to prevent injuries, accidents, and possible damage to the vehicle.
 -  **WARNING:** Indicates a situation in which serious injury or death could result if the warning is ignored.
 -  **CAUTION:** Indicates a situation in which bodily injury or damage to the vehicle could result if the caution is ignored.
- For areas indicating the tightening torque in this instruction manual, tighten to the specified torque using a torque wrench. For areas in which the tightening torque is indicated inside parentheses (), the tightening torque is indicated as a reference value, however tightening using a torque wrench is not necessary.
- Do not modify the car-navigation unit.
- Do not install the car-navigation unit in any way other than described in the following instructions.
- If in any doubt, please ask your Mazda dealer to install the accessory in order to prevent errors in installation.
- If you have any questions about the use of the accessory, ask your Mazda dealer for proper advice before using it.
- Mazda and its suppliers are not responsible for injuries, accidents, and damage to persons and property that arise from the failure of the dealer or installer to follow these instructions.
- To ensure safety and reliability of the work, installation, removal and disposal work must be carried out by an Authorized Mazda Dealership.
- Be careful not to lose removed parts, and be sure that they are kept free from scratches, grease or other dirt.

PART NAME: CAR-NAVIGATION UNIT
PART NUMBER: GJY3 79 EZX (MEXICO)
KJY2 79 EZX (US/CANADA)
VEHICLE: MAZDA CX-5

NOTE

To the dealer

- Please turn over these instructions to the customer after installation.

To the customer

- Keep these instructions after installation. The instructions may be necessary for installing other optional parts or removal of this accessory.
- Should the vehicle or this accessory be resold, always leave these instructions with it for the next owner.

GB

F

E

1. INSTALLATION

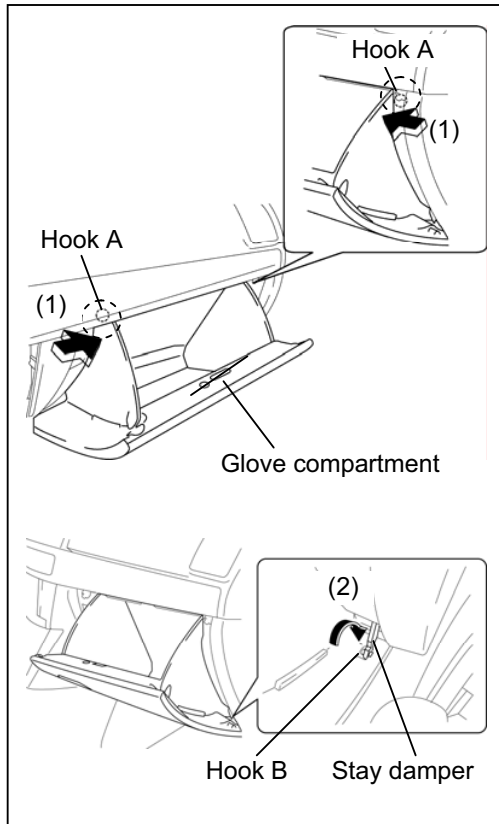

GPS CONNECTOR INSTALLATION (US/CANADA only)

Glove compartment removal

1. Push the glove compartment in the direction of the arrow (1) and hooks A.
2. Pull the stay damper in the direction of the arrow (2) shown in the figure and remove the hook B.

⚠ CAUTION

- If the glove compartment is closed without being joined to the stay damper, the stay damper may be damaged. Verify that the stay damper is joined to the glove compartment before closing the glove compartment.

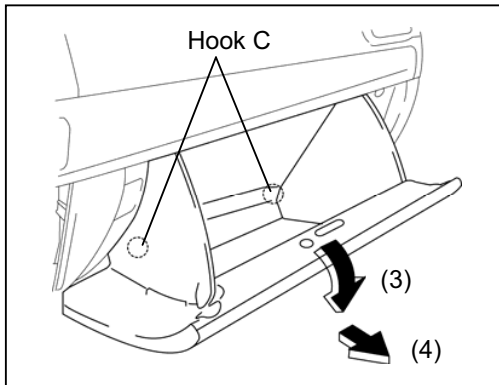

3. Pull down the glove compartment in the direction of the arrow (3).
4. Pull the glove compartment in the direction of the arrow (4) and remove it while detaching hooks C.

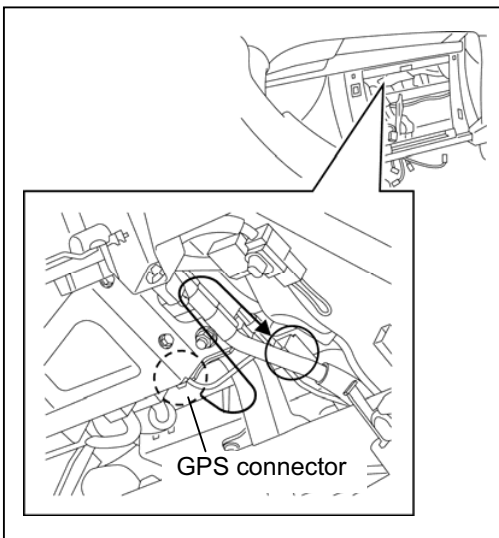

GPS connector installation

1. Disconnect the connector from the unit and connect it to the connector shown in the figure.
2. Install the glove compartment in the reverse order of removal.

IMPORTANT: Follow "SOFTWARE DOWNLOAD PROCEDURE" and "REFLASH PROCEDURE" (shown as last 2 pages of this instruction) before proceeding.

2. OPERATION CHECK

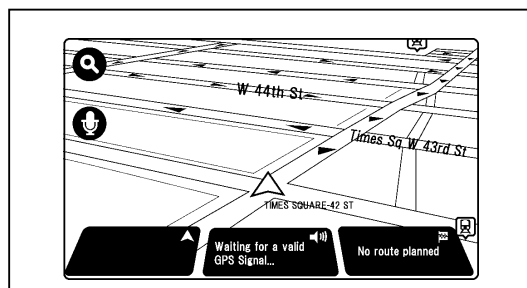
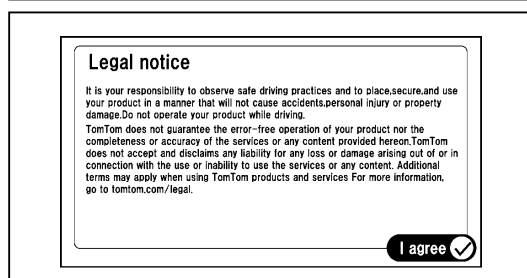
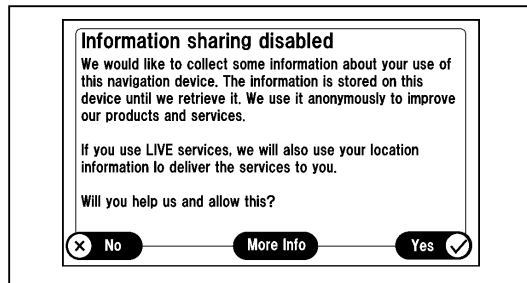
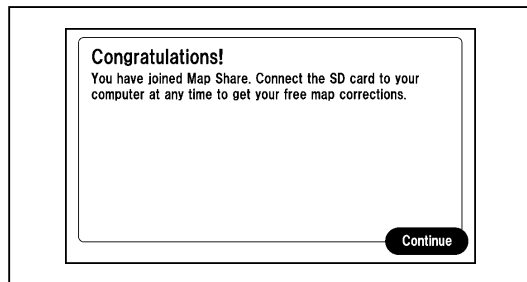
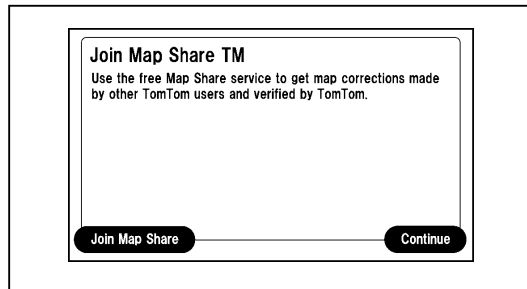
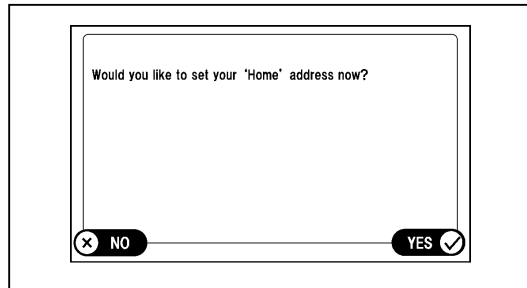

Reset procedure

- This procedure is in Step 3 of "Connection verification of +B/ACC connector and USB connector (Pg. 6)" of "5. OPERATION CHECK" of current INSTALLATION INSTRUCTIONS (KD37 79 EZX/KF69 79 EZX), and is implemented only if the "Continue" button is pressed by mistake and the screen advances too far.

1. Touch "No"

2. Touch "Join Map Share".

3. Touch "Continue".

4. Touch "Yes".

5. Touch "I agree".

6. Touch the screen.

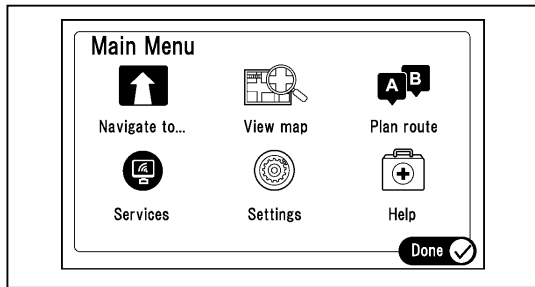

7. Touch "Setting".

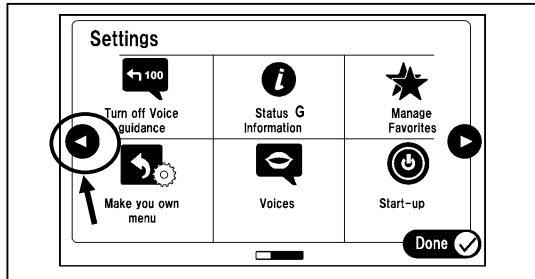

8. Touch the location shown in the figure.

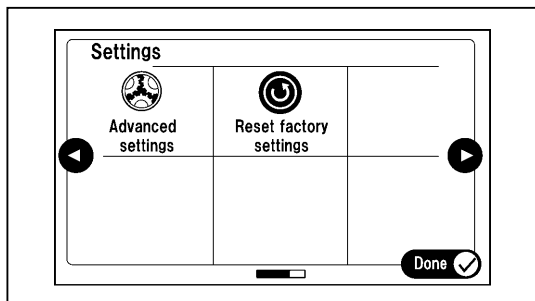

9. Touch "Reset factory setting".

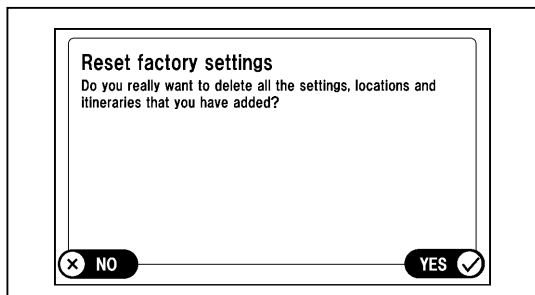

10. Touch "Yes".

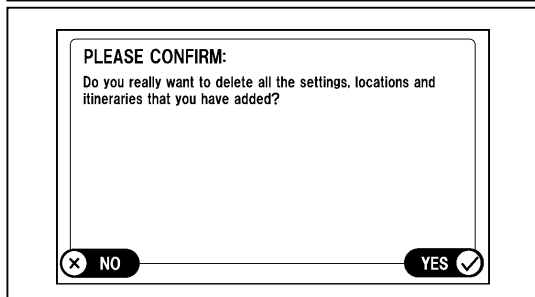

11. Touch "Yes".

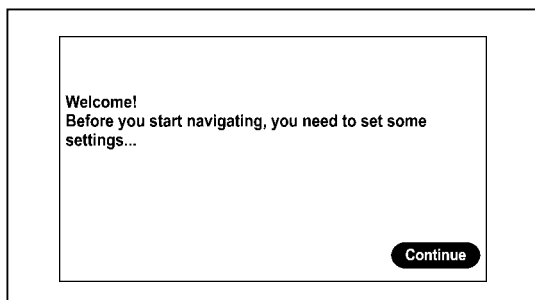

12. Setting is finished when "Welcome" screen appears.

13. Switch the ignition off.

INSTALLATION INSPECTION SHEET

MAZDA CX-5	CAR-NAVIGATION UNIT
	GJY3 79 EZX (MEXICO) KJY2 79 EZX (US/CANADA)

A. Vehicle parts reinstallation

- Install removed vehicle parts in the reverse order of "VEHICLE PARTS REMOVAL".

⚠ CAUTION

- Make sure that the vehicle parts are clean before reinstalling. Clean any dirty parts.
- Verify that the connectors are securely connected.

Check

B. Inspection after installation

- Inspect the installed / reinstalled parts for the following items.

Inspection Parts	Check Item (○)			
	Clearance/Fit	Scratches/ Dirt/ Harness interference	Installation/ Tightening/ Engagement	Operation check
Car-navigation unit	○	○	○	○
Glove compartment			○	
Negative battery cable		○	○	
Power window auto function				○
TPMS system				○

○ : Applicable

C. Important check items

- Inspect the installed / reinstalled parts for the following items.

Section	Parts Name	Tightening torque	Check
Installation of the negative battery cable	Nut	4.0—5.0 N·m	

Installation inspection sheet for car-navigation unit.

Date _____, _____, _____					
Vehicle. _____					
VIN. _____					
Approved		Checked		Person in charge	

The term of validity for this sheet: 3 years.

SOFTWARE DOWNLOAD PROCEDURE

Downloading Update Software to a SD card (if already completed skip to Reflash procedure)

1. Insert a new blank 512 MB (minimum) to 16 GB (maximum) SD card into the SD card slot of a computer with internet access. Make sure the SD card is in the “unlocked” position.

NOTE: DO NOT use the customer’s MAP SD card to update the system.

2. Go to “Start” and select “Computer,” then double-click on the SD card “removable disk”.
3. Delete any existing files.
4. Confirm that no files are left on the SD card.
5. Log on to MS3 and select “IDS/Infotainment.”

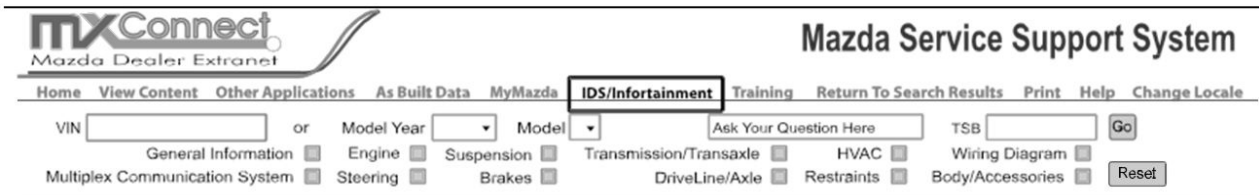

6. Select “TomTom Updates.”



7. Select “Click Here” to read the TomTom - End-User License Agreement (EULA).
8. After reading the TomTom - EULA, select “I AGREE” to gain access to the update file.
9. Save the “10.851.1441501_ECR9.5.1-CAB-Fuji.cab” to the desktop, then double click to open.
10. Copy the two update files to the SD card
11. Right click the two files and select “Properties” to make sure the files are “Read Only.” If not, check the box to make the file “Read Only” and then select “OK.”

NOTE: The files are made “Read Only” so that the system will not erase the files off the SD card during the update process. You can then continue to use this SD card to update other vehicles.

12. Remove the update SD card from the computer.

NOTE: The update files can also be copied to other SD cards.

REFLASH PROCEDURE

1. Turn the ignition OFF.

NOTE: For customer vehicles, verify that the navigation system software is not the latest. See TomTom Software Version Verification Procedure.

2. Open the sliding door of the navigation control unit and remove the customer's MAP SD card. Insert the update SD card and close the sliding door.
3. Turn the ignition ON and wait for the audio system to turn on.
4. Press the "NAV" button to switch to the navigation screen.

NOTE: It will take up to 1 minute to show the software update screen. First the hour glass appears, then you can select the "check mark" or wait 5 seconds and the software loading will start (progress bar is filled from 0%-100%).

CAUTION: DO NOT remove the SD card or turn the ignition OFF during software loading.

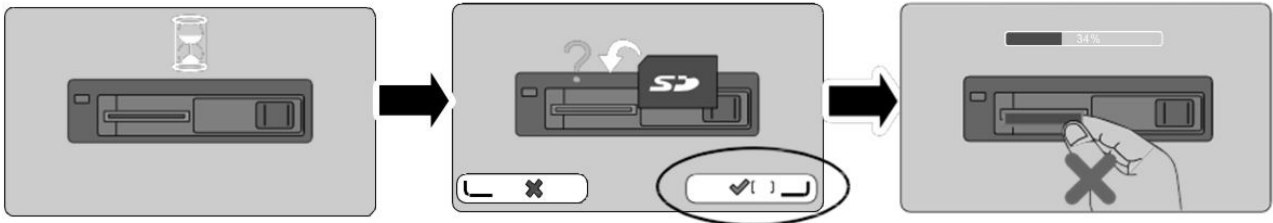

5. After the completion of the software update, the system will reboot and show a screen that says "No map data found." Turn the ignition OFF and remove the update SD card. The software update is complete.

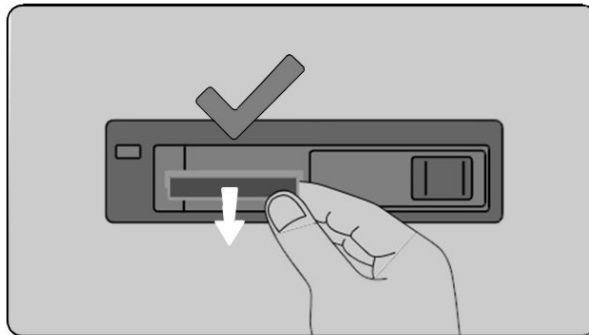

6. Insert the customer's MAP SD card and turn the ignition ON.